

SG160S

Safety Group

with interchangeable safety valve insert

APPLICATION

Safety groups of this type are used to protect pressurised water heaters according to the requirements of DIN 4753-1 and EN 806-2.

They are compact appliances which incorporate all the necessary safety devices such as check valve, shut-off valve, test point and diaphragm type safety valve in one unit.

The safety valve protects the downstream cylinder, pressure vessel etc. by automatically opening when excess pressure occurs. The check valve prevents back pressure, backflow and back syphonage of water from the hot water unit.

APPROVALS

- DVGW-certified

SPECIAL FEATURES

- Tested according DIN EN 1488
- Fully approved for noise level protection to class 1
- Meets UBA regulations for drinking water
- Replacement insert makes servicing simple
- Easy venting
- Standardised discharge connection



TECHNICAL DATA

For closed water heaters in compliance with DIN 4753-1 and EN 806-2/1988-200.

Media	
Medium:	Drinking water
Connections/Sizes	
Connection size:	1/2" - 1"
Pressure values	
Opening pressure:	6.0, 8.0 or 10 bar*
Max. operating pressure:	Maximum at least below 20 % opening pressure of safety
Operating temperatures	
Max. operating temperature medium:	40 °C
Specifications	
Installation position:	Horizontal and vertical

* Subsequent alteration of the setting is not permitted and is impossible without destroying the security cap

CONSTRUCTION

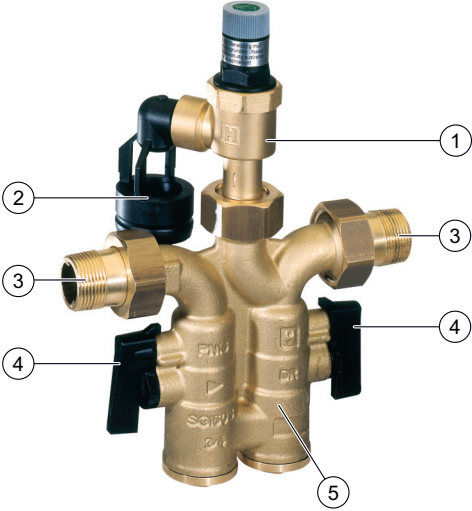
Overview	Components	Materials
	1 Safety valve	High-quality synthetic material with brass housing
	2 Drain connector	High-quality synthetic material
	3 Connections (versions AA, AB and AC)	Brass
	4 Shut-off valves	High-quality synthetic material
	5 Housing with G 1/4" test socket on both sides	Dezincification-resistant brass
Not depicted components		
	Safety valve exchange insert	High-quality synthetic material
	Removable check valve	High-quality synthetic material
	Diaphragm	EPDM
	Seals	EPDM

METHOD OF OPERATION

Safety groups of this type combine check valve, shut-off valve, test point and diaphragm type safety valves in one appliance. Flow first passes through the check valve and this flow holds the valve disc in the open position against the force of a spring.

The downstream safety valve is a direct operating safety valve. That is, the opening force operates against the force of a spring. The shut-off valve enable the check valve to be checked and serviced.

TRANSPORTATION AND STORAGE

Keep parts in their original packaging and unpack them shortly before use.

The following parameters apply during transportation and storage:

Parameter	Value
Environment:	clean, dry and dust free
Min. ambient temperature:	5 °C
Max. ambient temperature:	55 °C
Min. ambient relative humidity:	25 % *
Max. ambient relative humidity:	85 % *

*non condensing

INSTALLATION GUIDELINES

Setup requirements

- Safety group must be fitted in the cold water supply to the hot water storage unit
- Horizontal and vertical installation position possible
- The installation must be carried out so that:
 - There are no shut-off valves or fittings, narrowing of the pipework or strainers between the water heater and the safety valve
 - Good access is provided for service and maintenance
 - The safety valve is fitted above the top of the water heater to avoid the need for draining down when exchanging the safety valve insert
- If there is no drainage facility in the room where the heater is installed, then the safety valve may be fitted in an adjacent area. DIN 1988-200 is to be observed
- Requires regular maintenance in accordance with EN 806-5

Installation Example

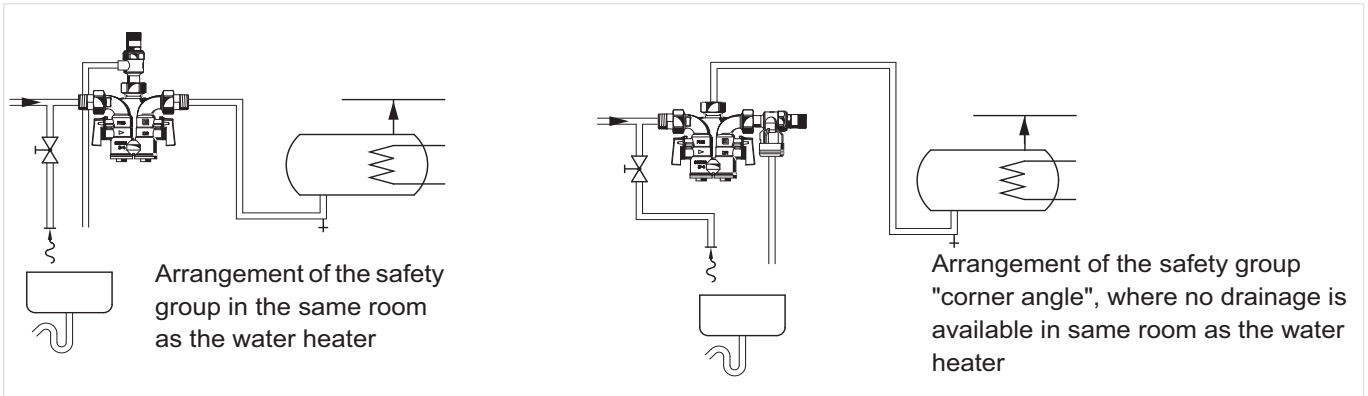
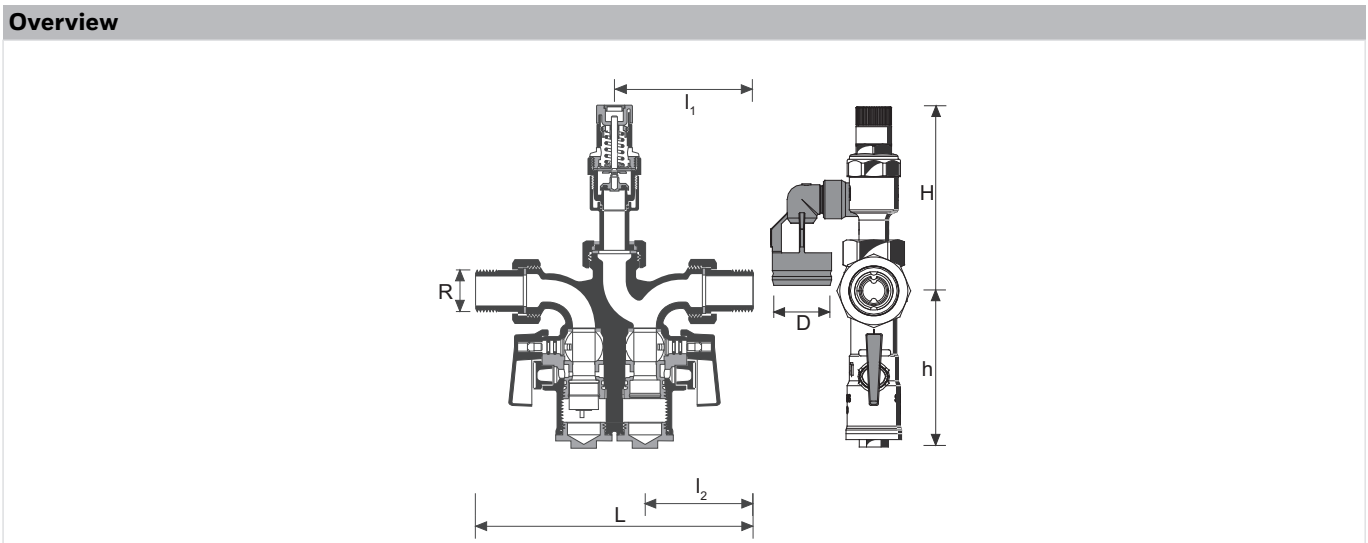

Fig. 1 Standard installation example for the safety group

DIMENSIONS



Parameter		Values		
Connection size:	R	1/2"	3/4"	1"
Nominal size:	R	3/4"	3/4"	3/4"
Weight:	kg			
	Version A	1.64	1.7	1.96
	Version E	-	1.4	1.57
Drain outside Ø:	D	40	40	40
Dimensions:	mm			
	L	178	186	204
	l ₁	89	93	102
	l ₂	68.5	72.5	81.5
	H	124.5	124.5	124.5
	h	105.5	105.5	105.5
For water heaters with capacity*:	litres	200	1000	1000
Max. permissible heat input*:	kW	75	150	150
DIN/DVGW Approval No.:		NW-6311 CQ 0546		

Note: All dimensions in mm unless stated otherwise.

* Concerning DIN 1988-200

ORDERING INFORMATION

The following tables contain all the information you need to make an order of an item of your choice. When ordering, please always state the type, the ordering or the part number.

Options

The valve is available in the following sizes: 1/2", 3/4" and 1" (E-Version only in 3/4" available).





- standard
- not available

		SG160S- ...AA	SG160S- ...AB	SG160S- ...AC	SG160S- ...EA	SG160S- ...EB	SG160S- ...EC
With threaded male connections:	6 bar	•	-	-	-	-	-
	8 bar	-	•	-	-	-	-
	10 bar	-	-	•	-	-	-
Without fittings:	6 bar	-	-	-	•	-	-
	8 bar	-	-	-	-	•	-
	10 bar	-	-	-	-	-	•

Note: ... = space holder for connection size

Note: Ordering number example for 1/2" and type AA valve: SG160S-1/2AA

Accessories

	Description	Dimension	Part No.
	M07M Pressure gauge		
	Housing diameter 63 mm, rear connection thread G 1/4"		
	Range: 0 - 4 bar		M07M-A4
	Range: 0 - 10 bar		M07M-A10
	Range: 0 - 16 bar		M07M-A16
	Range: 0 - 25 bar		M07M-A25
	VSTM Connection for pressure gauge		
		1/2"	VSTM-1/2A
		3/4"	VSTM-3/4A
		1"	VSTM-1A
	VST06A Connection set		
	Threaded connections		
		1/2"	VST06-1/2AR
		3/4"	VST06-3/4A
		1"	VST06-1A
	VST06B Connection set		
	Solder connections		
		1/2"	VST06-1/2BR
		3/4"	VST06-3/4B
		1"	VST06-1B

Spare Parts

Safety Group SG160S, from 2004 onwards

Overview	Description	Dimension	Part No.
	1 Valve insert complete		
	6 bar	1/2" - 1"	SV152-3/4AA
	8 bar	1/2" - 1"	SV152-3/4AB
	10 bar	1/2" - 1"	SV152-3/4AC
	2 Blanking plug with O-ring R1/4" (5 pcs.)		
		1/4"	S06K-1/4
	3 Discharge tundish		
			TA160S
	4 Check valve		
		3/4"	2110200
	5 Union seal washer (10 pcs.)		
		1/2" + 3/4"	0901444
		1"	0901445

Environmental & Energy Solutions

Honeywell GmbH
 Hardhofweg
 74821 MOSBACH
 GERMANY
 Phone: (49) 6261 810
 Fax: (49) 6261 81309
<http://ecc.emea.honeywell.com>

Manufactured for and on behalf of the
 Environmental and Combustion Controls
 Division of Honeywell Technologies Sàrl, Z.A.
 La Pièce 16, 1180 Rolle, Switzerland
 by its Authorised Representative Honeywell GmbH
 EN0H-1346GE23 R0517
 Subject to change
 © 2017 Honeywell GmbH

